

ISL9492

Ordering Information

PART NUMBER (Notes 1, 2, 3)	PART MARKING	TEMP. RANGE (°C)	PACKAGE (Pb-free)	PKG. DWG. #
ISL9492ERZ	94 92ERZ	-20 to +85	28 Ld 4x4 TQFN	L28.4x4A
ISL9492QFNEVAL1	Evaluation Board			

1. Add “-T*” suffix for tape and reel. Please refer to [TB347](#) for details on reel specifications.
2. These Intersil Pb-free plastic packaged products employ special Pb-free material sets, molding compounds/die attach materials, and 100% matte tin plate plus anneal (e3 termination finish, which is RoHS compliant and compatible with both SnPb and Pb-free soldering operations). Intersil Pb-free products are MSL classified at Pb-free peak reflow temperatures that meet or exceed the Pb-free requirements of IPC/JEDEC J STD-020.
3. For Moisture Sensitivity Level (MSL), please see device information page for [ISL9492](#). For more information on MSL please see techbrief [TB363](#).

Pin Configuration

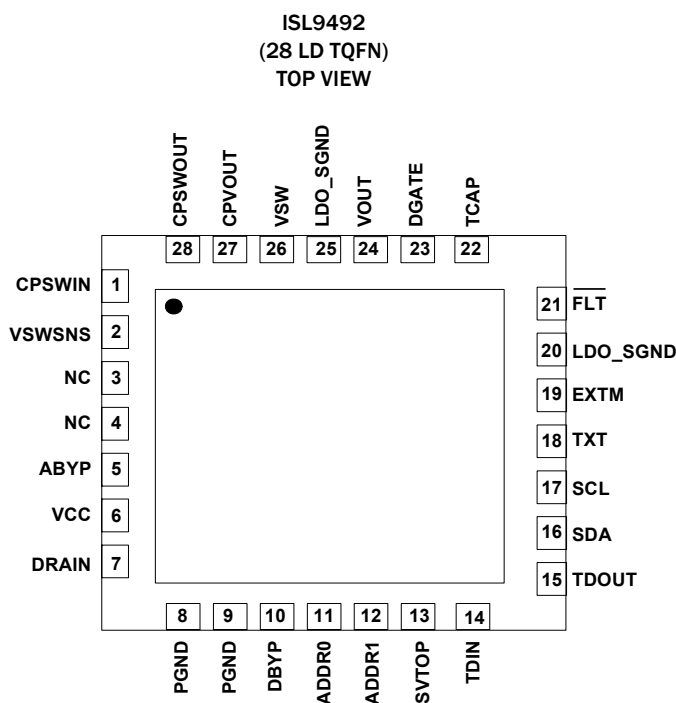

Functional Pin Descriptions

PIN	SYMBOL	FUNCTION
1	CPSWIN	Charge pump connection 1
2	VSWSNS	Boost regulator sense line. Connect to boost output capacitor.
3, 4	NC	No connect pins
5	ABYP	Analog 5V supply. Decouple with 1 μ F ceramic capacitor and a ferrite bead (see “ABYP” on page 14 for more detail).
6	VCC	Main power supply to the chip.
7	DRAIN	This is the Drain of the Boost MOSFET. The Boost inductor will be connected to this pin.
8,9	PGND	Power ground for the Internal Boost MOSFET.
10	DBYP	Digital 5V supply. Decouple with 1 μ F ceramic capacitor.
11, 12	ADDR0, ADDR1	Logic combination at the ADDR0 and ADDR1 can select four different chip select addresses.
13	SVTOP	External control of output voltage selection.
14	TDIN	Tone detector input.
15	TDOUT	The envelope of the actually detected external tone signal. It is an open-drain output.

ISL9492

Functional Pin Descriptions (Continued)

PIN	SYMBOL	FUNCTION
16	SDA	Bidirectional data from/to I ² C bus.
17	SCL	Clock from I ² C bus.
18	TXT	Tx, Rx switch control
19	EXTM	This pin can be used in two ways: 1. To drive TONE with the actual tone signal directly. 2. To drive TONE with the envelope of the actual tone signal to be generate by this device.
20, 25	LDO_SGND	Small signal ground for the internal LDO.
21	$\overline{\text{FLT}}$	This is an open drain output from the controller. It will go LOW when any of the fault flags is set.
22	TCAP	Capacitor for setting rise and fall time of the output voltage. Typical value is 0.1 μ F.
23	DGATE	Connect to an external PMOS gate to short the RLC tank circuit during 22kHz tone transmission.
24	VOUT	Linear regulator output provides the LNB power.
26	VSW	Input to the linear regulator that actually provides the LNB output voltage.
27	CPVOUT	Output of charge pump.
28	CPSWOUT	Charge pump connection 2.
-	Pad	There is no connection with this pin. EPAD also has no connection and should be connected to GND plane with multiple vias.

Block Diagram

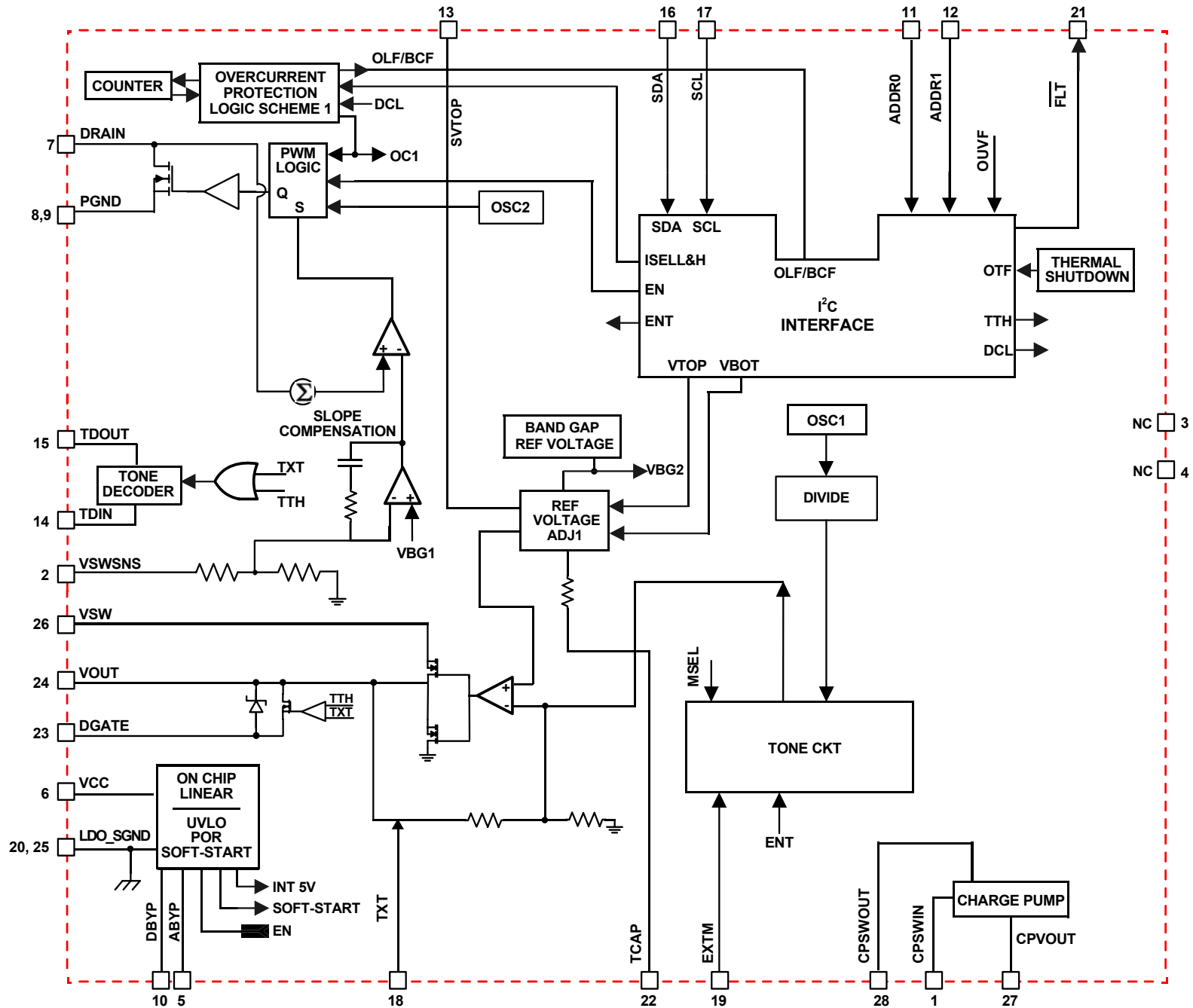

ISL9492

Typical Application Schematic

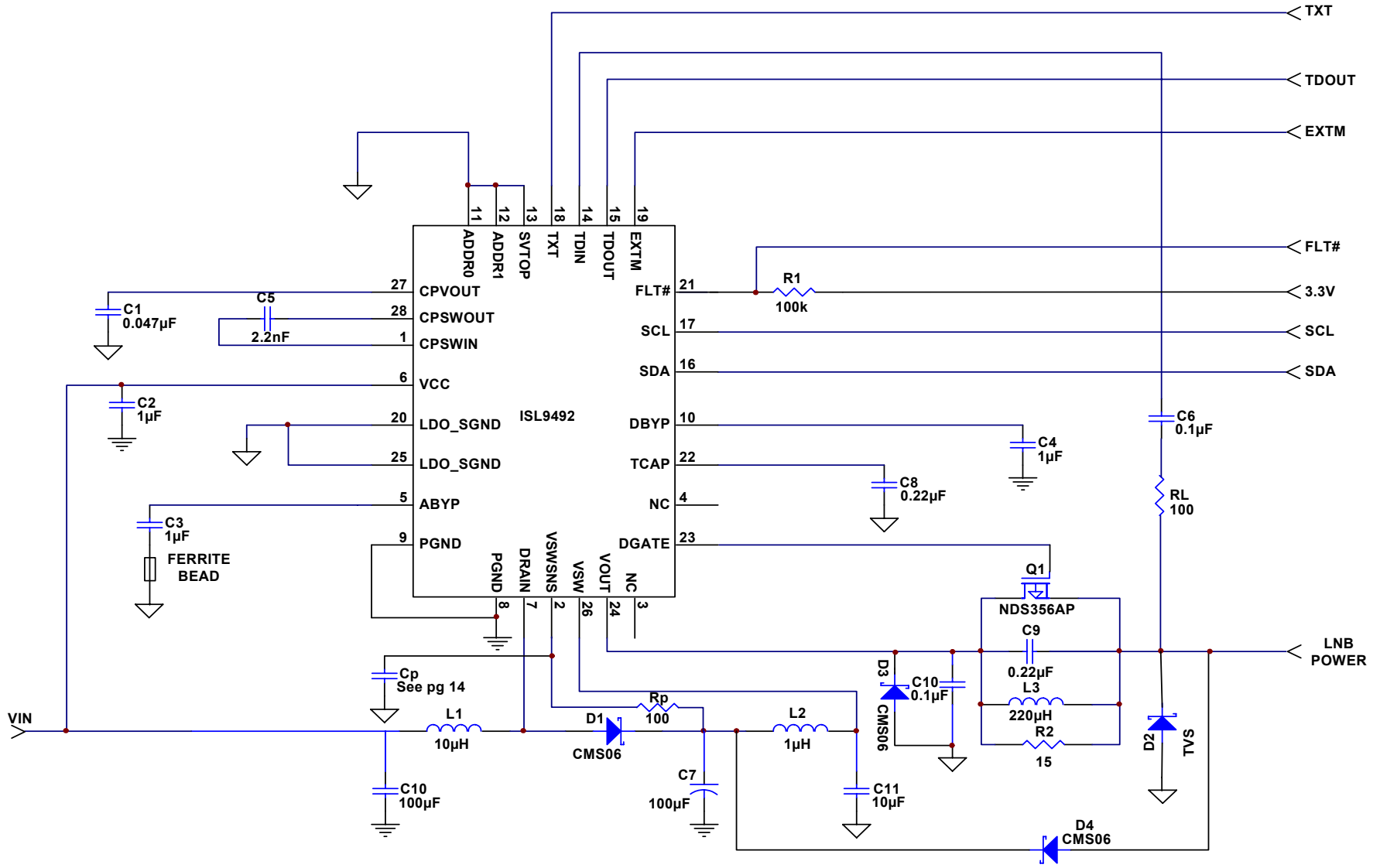

Table of Contents

Functional Pin Descriptions	2
Block Diagram	4
Typical Application Schematic	5
Absolute Maximum Ratings	7
Thermal Information	7
Recommended Operating Conditions	7
Electrical Specifications	7
Tone Waveform	9
Typical Performance Curves	10
Derated Performance Curve	13
Functional Description	14
DiSEqC Encoding	14
DiSEqC Decoder	14
ABYP	14
Device Enable	14
DiSEqC External MOSFET	14
Linear Regulator	14
Boost Regulator Inductor and Output Capacitor Selection	14
Output Timing	14
Output Voltage Selection	15
Current Limiting	15
Thermal Protection and Fault Indicator	15
I2C Bus Interface for ISL9492	15
Data Validity	15
START and STOP Conditions	16
Byte Format	16
Acknowledge	16
Transmission Without Acknowledge	16
ISL9492 Software Description	16
Interface Protocol	16
System Register Format	16
Transmitted Data (I ² C Bus WRITE Mode)	16
Received Data (I2C bus READ MODE)	18
Power-On I2C Interface Reset	18
ADD0 and ADD1 Pins	18
Layout Guidelines	19
Revision History	20
Products	20
Package Outline Drawing	21

ISL9492

Absolute Maximum Ratings

V _{CC} (Supply Voltage)	8V to 18V
V _{OUT}	-0.3V to 36V
V _{SW} , Drain	-0.3V to 24V
All Other Pins	-0.3V to 5.5V
All Pins Referenced to Ground	
ESD Rating	
Human Body Model (Tested per JESD22-A114E)	3kV
Machine Model (Tested per JESD22-A115-A)	200V
Charged Device Model	2kV
Latch Up (Tested per JESD-78B; Class 2, Level A)	100mA

Thermal Information

Thermal Resistance	θ_{JA} (°C/W)	θ_{JC} (°C/W)
TQFN Package (Notes 4, 5)	38	3
Maximum Junction Temperature (Note 6)	+150°C	
Maximum Storage Temperature Range	-40°C to +150°C	
Pb-Free Reflow Profile	see link below http://www.intersil.com/pbfree/Pb-FreeReflow.asp	

Recommended Operating Conditions

Ambient Temperature	-20°C to +85°C
---------------------	----------------

CAUTION: Do not operate at or near the maximum ratings listed for extended periods of time. Exposure to such conditions may adversely impact product reliability and result in failures not covered by warranty.

NOTES:

- θ_{JA} is measured in free air with the component mounted on a high effective thermal conductivity test board with "direct attach" features. See Tech Brief TB379.
- For θ_{JC} , the "case temp" location is the center of the exposed metal pad on the package underside.
- The device junction temperature should be kept below +150°C. Thermal shutdown circuitry turns off the device if junction temperature exceeds +150°C typically.

Electrical Specifications V_{CC} = 12V, T_A = -20°C to +85°C, unless otherwise noted. Typical values are at T_A = +25°C. EN = 1, VTOP = 0, V_{BOT} = 0, ENT = 0, V_{OUT} Load = 100mA, unless otherwise noted. See "ISL9492 Software Description" on page 16 for I²C access to the system. **Boldface limits apply over the operating temperature range, -20°C to +85°C.**

PARAMETER	SYMBOL	TEST CONDITIONS	(Note 7)	MIN (Note 8)	TYP	MAX (Note 8)	UNITS
Operating Supply Voltage Range			F	8	12	14	V
Standby Supply Current		EN = 0	F	-	3.6	-	mA
Supply Current	I _{IN}	VTOP = V _{BOT} = EN = 1, DLIN = 0, V _{OUT} = No load	F	-	6	10	mA
Supply Current	I _{VSW}	VTOP = V _{BOT} = EN = DLIN = 1, No load	F	-	-	20	mA
Temperature Shutdown Threshold			F	-	150	-	°C
Temperature Shutdown Hysteresis			F	-	20	-	°C
UNDERVOLTAGE LOCKOUT BOOST							
Falling Threshold	OVL	V _{CC} Falling from above 8V (Note 9)	F	-	6.8	-	V
Rising Threshold	OVL	V _{CC} Rising from 0V	F	-	7.35	-	V
BOOST CONVERTER							
Boost MOSFET Drain Current Limit			F	-	4	-	A
Boost MOSFET ON-Resistance			F	-	520	-	mΩ
LINEAR REGULATOR							
Output Voltage		13V (see Table 1)	P	13.2	13.5	13.8	V
		14V (see Table 1)	P	13.9	14.2	14.5	V
		18V (see Table 1)	P	18.2	18.5	18.8	V
		20V (see Table 1)	P	19.7	20	20.3	V
Dropout Voltage	V _{DROP}	V _{OUT} Load = 750mA (Note 9)	F	-	0.4	-	V
T _{CAP} Current (Output Soft-start Control)		T _{CAP} = 0V	F	8	10	12	μA
Output Undervoltage (Asserted High During Soft-start)		OUVF bit is asserted high, Measured from the typical output set value	P	-12	-	-2	%
Output Overvoltage (Asserted High During Soft-start)		OUVF bit is asserted high, Measured from the typical output set value	P	+2	-	+12	%

ISL9492

Electrical Specifications $V_{CC} = 12V$, $T_A = -20^{\circ}C$ to $+85^{\circ}C$, unless otherwise noted. Typical values are at $T_A = +25^{\circ}C$. $EN = 1$, $V_{TOP} = 0$, $V_{BOT} = 0$, $ENT = 0$, V_{OUT} Load = 100mA, unless otherwise noted. See "ISL9492 Software Description" on page 16 for I²C access to the system. **Boldface limits apply over the operating temperature range, -20°C to +85°C. (Continued)**

PARAMETER	SYMBOL	TEST CONDITIONS	(Note 7)	MIN (Note 8)	TYP	MAX (Note 8)	UNITS
Line Regulation		$V_{CC} = 8V$ to $14V$; $V_{OUT} = 13V$ @ 350mA	P	-	4	40	mV
		$V_{CC} = 8V$ to $14V$; $V_{OUT} = 18V$ @ 350mA	P	-	4	60	mV
Load Regulation		V_{OUT} Load = 0mA to 350mA	P	-	50	80	mV
		V_{OUT} Load = 0mA to 750mA	P	-	100	200	mV
Current Limiting	I_{MAX}	ISELH = 0, ISELL = 0, DCL bit = 0 (Note 10)	P	850	950	1050	mA
		ISELH = 1, ISELL = 0, DCL bit = 0 (Note 10)	P	600	670	740	mA
		ISELH = 0, ISELL = 1, DCL bit = 0 (Note 10)	P	710	790	870	mA
		ISELH = 1, ISELL = 1, DCL bit = 0 (Note 10)	P	370	400	450	mA
Cable Fault CABF Threshold	I_{CAB}	$V_{OUT} = 20V$, No Tone	P	2	20	50	mA
Back-Biased Current		$V_{OUT} = 21V$ from External Source	P	-	-	10	mA
tone oscillator (TONE) (Note 8)							
Tone Frequency	f_{tone}	ENT = 1	P	20	22	24	kHz
Tone Amplitude	V_{tone}	ENT = 1, with Proper DiSEqC Tank Circuit	P	500	680	800	mV
Tone Duty Cycle	dc_{tone}	ENT = 1	P	-	50	-	%
Tone Rise or Fall Time	t_r, t_f	ENT = 1	P	5	10	14	μs
tone decoder (TDIN, TDOUT)							
Frequency Capture Range	F_{tdin}		P	18	-	26	kHz
Input Impedance	Z_{det}		F	-	8.6	-	k Ω
Detector Output Voltage	V_{tdout_L}	Tone Present, Sink Current = 3mA	P	-	-	0.4	V
Detector Output Leakage (Open Drain)	I_{tdout_H}	Tone Absent	P	-	-	10	μA
Tone Decoder Rx Threshold (Note 10)	V_{RXth}	TTH bit = 0 and TXT pin = 0	P	200	-	-	mV _{P-P}
Tone Decoder Tx Threshold (Note 10)	V_{TXth}	TTH bit = 1 or TXT pin = 1	P	400	-	-	mV _{P-P}
logic interface (INPUT = EXTM, SVTOP, ADD0, ADD1, TXT, SCL, SDA, OUTPUT = FLT)							
Input Logic LOW			F	-	-	0.8	V
Input Logic HIGH			F	2.0	-	-	V
Input Current			F	-	25	-	μA
Input Pull-down Resistance			F	-	200	-	k Ω
Output Logic LOW		Fault Detected, Sink Current = 3mA	F	-	-	0.4	V
Output Logic High Leakage (Open Drain)		No Fault	F	-	-	10	μA

NOTES:

- F = Functional check; P = Probe or final test
- Compliance to datasheet limits is assured by one or more methods: production test, characterization and/or design.
- Output voltage can only be maintained in regulation if the input voltage is within the specified range.

Tone Waveform

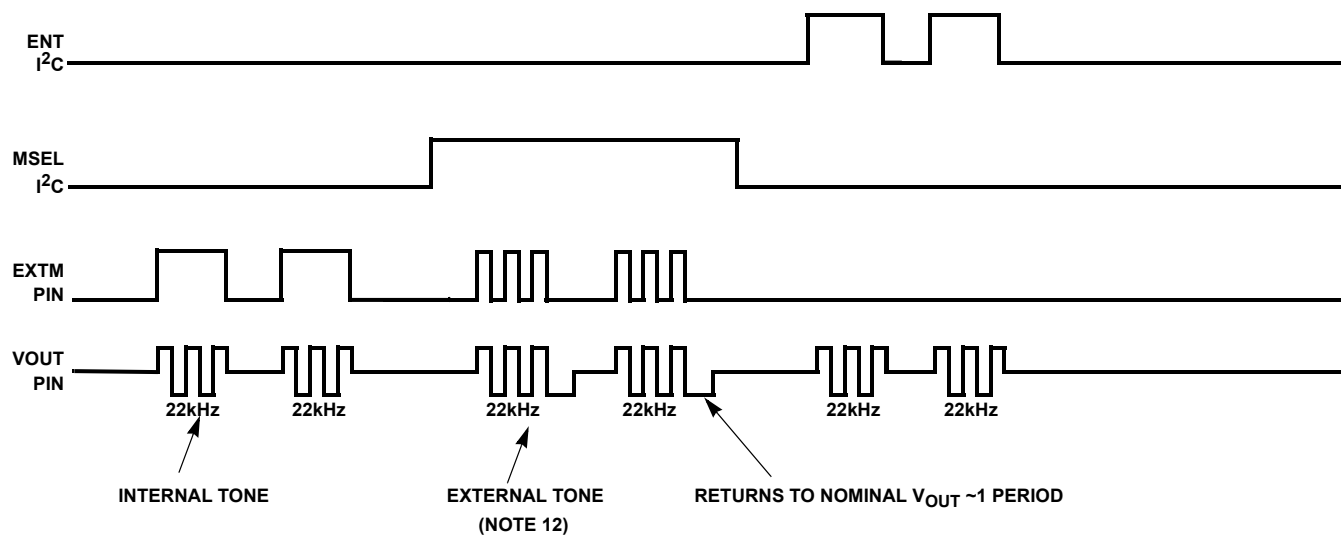

NOTES:

10. TTH allows threshold control through the I²C Interface.
11. Compliance to datasheet limits is assured by one or more methods: production test, characterization and/or design.
12. The tone rise and fall times are not shown due to resolution of graphics.

FIGURE 2. TONE WAVEFORM

Typical Performance Curves

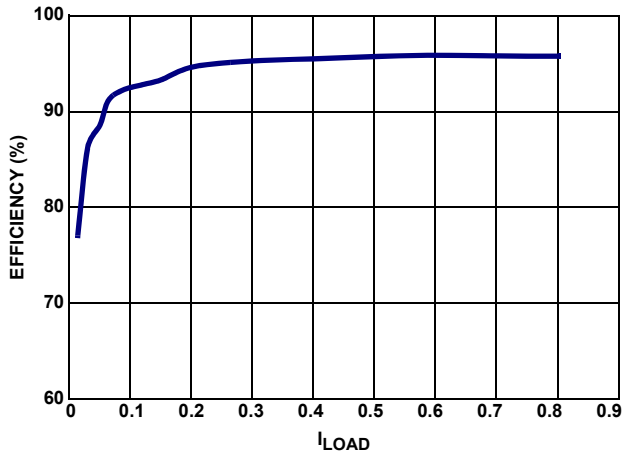

FIGURE 3. BOOST EFFICIENCY FOR 12V_{IN} TO 14.3V_{OUT}

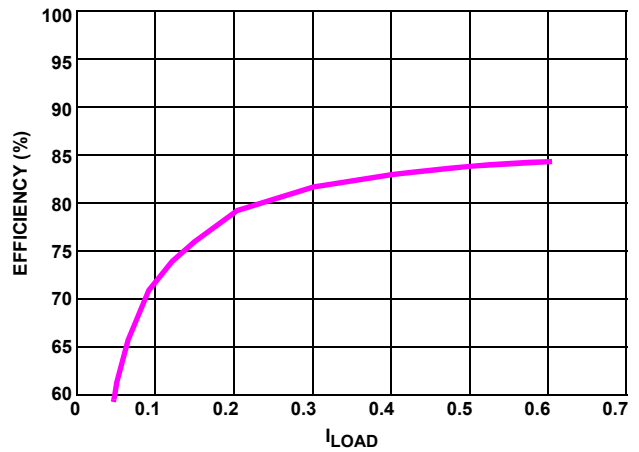

FIGURE 4. SYSTEM EFFICIENCY (BOOST + LDO) FOR 12V_{IN} TO 13.3V_{OUT}

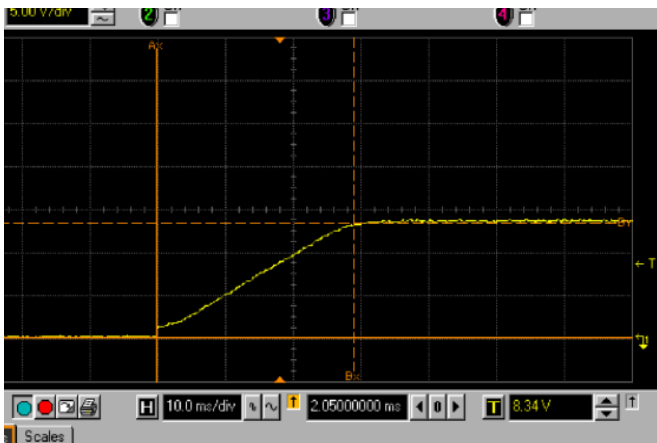

FIGURE 5. V_{LNB} RISE TIME = 29ms, T_{CAP} = 0.22µF

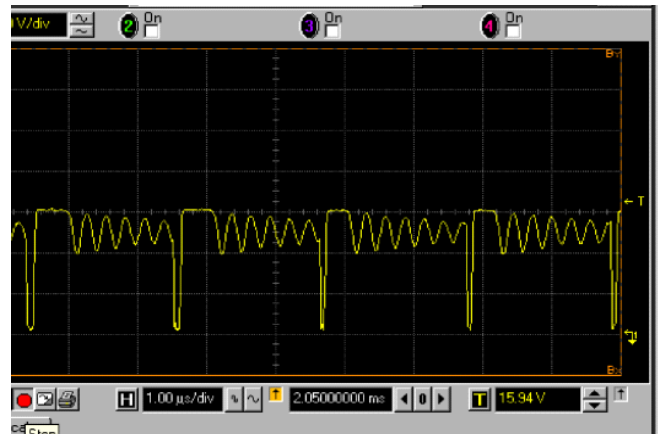

FIGURE 6. BOOST SWITCH NODE AT 0A (DISCONTINUOUS)



FIGURE 7. BOOST SWITCH NODE AT 100mA (PARTIAL DISCONTINUOUS)

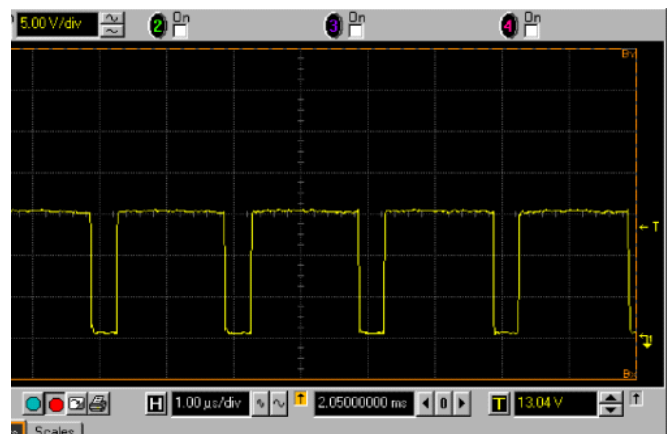

FIGURE 8. BOOST SWITCH NODE AT 300mA (CONTINUOUS MODE)

Typical Performance Curves (Continued)

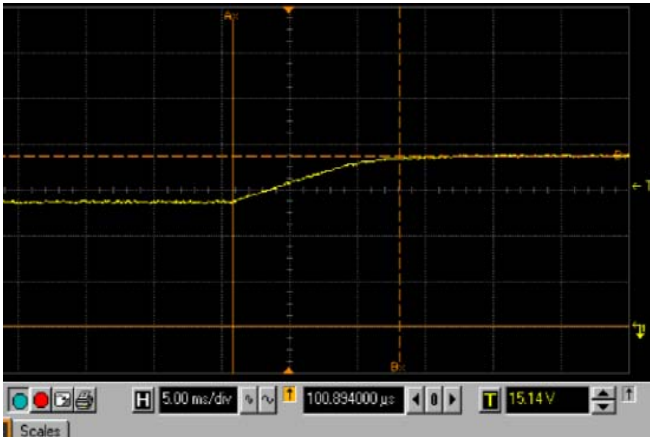

FIGURE 9. VLNb TRANSITIONS FROM 13.3V TO 18.3V

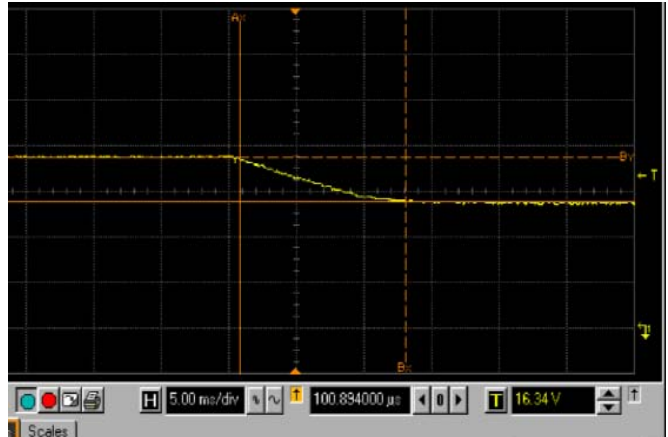

FIGURE 10. VLNb TRANSITIONS FROM 18.3V TO 13.3V

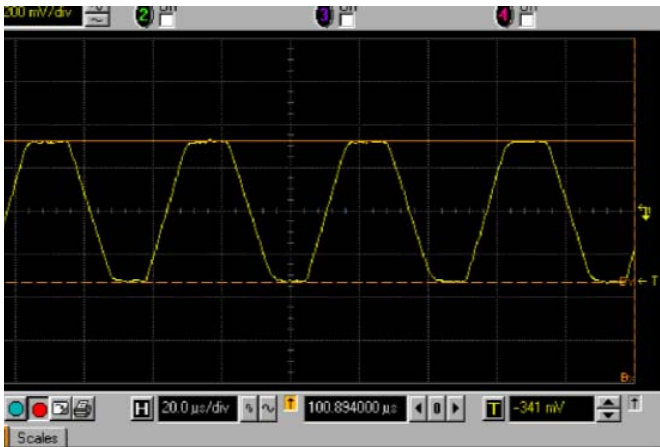

FIGURE 11. 22kHz TONE AT NO-LOAD

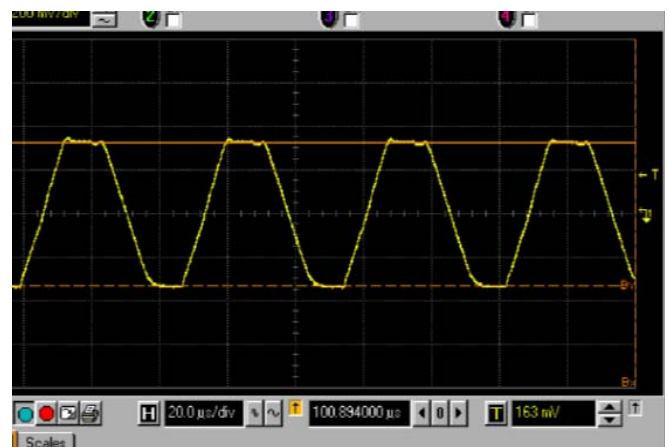

FIGURE 12. 22kHz TONE AT 700mA

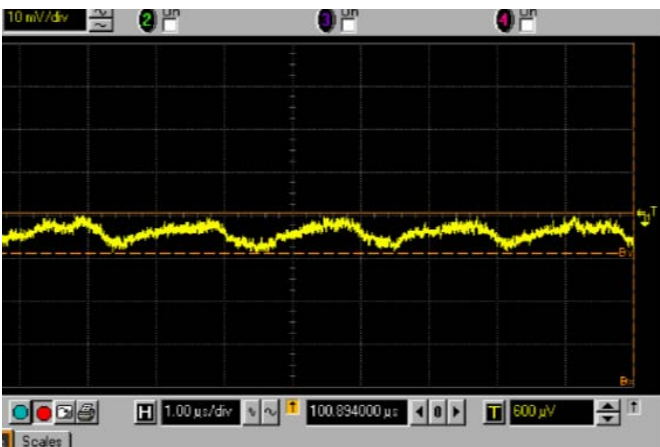

FIGURE 13. AC NOISE ON 13.3V_{OUT} AT 700mA IS ~ 10mV

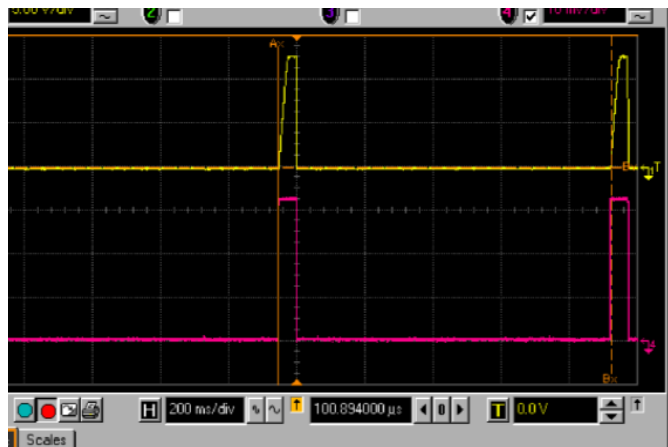

FIGURE 14. DYNAMIC CURRENT LOOP STARTED TO ENABLE. TOP IS VLNb AND BOTTOM IS LOAD CURRENT WAVEFORM (200mA/DIV)

Typical Performance Curves (Continued)

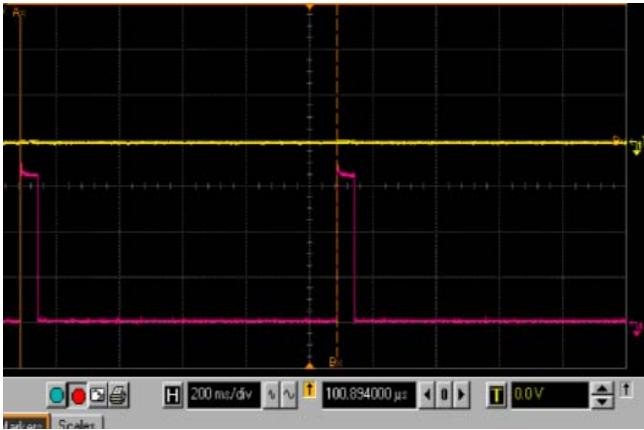

FIGURE 15. ISL9492 SHORTED TO GND IN DYNAMIC MODE. TOP IS VLN AND BOTTOM IS LOAD CURRENT WAVEFORM (200mA/DIV)

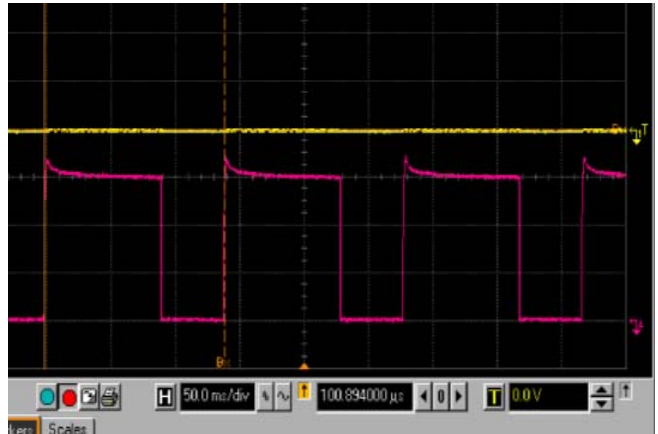

FIGURE 16. ISL9492 SHORTED TO GND IN STATIC MODE CAUSES THERMAL SHUTDOWN. TOP IS VLN AND BOTTOM IS LOAD CURRENT WAVEFORM (200mA/DIV)

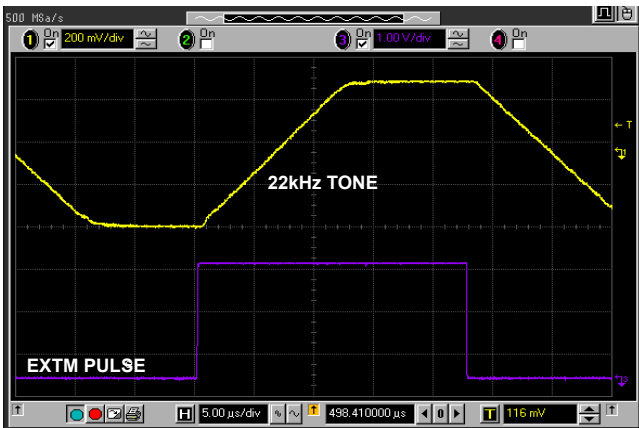

FIGURE 17. ISL9492 EXTm SIGNAL GOING LOW TO HIGH AND HIGH TO LOW vs TONE ENABLED ON OUTPUT DELAY

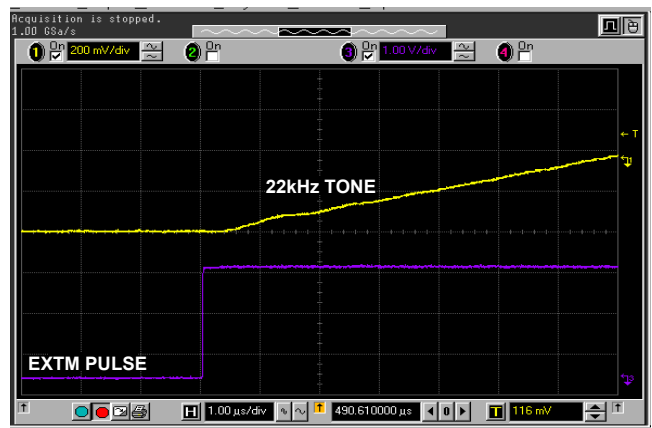

FIGURE 18. EXTm GOING HIGH TO TONE ENABLED ON THE OUTPUT DELAY IS ~500ns

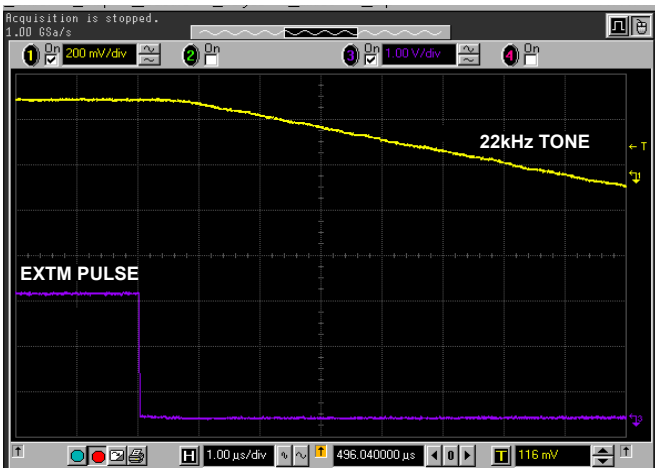

FIGURE 19. EXTm GOING LOW TO TONE DISABLED ON THE OUTPUT DELAY IS ~750ns

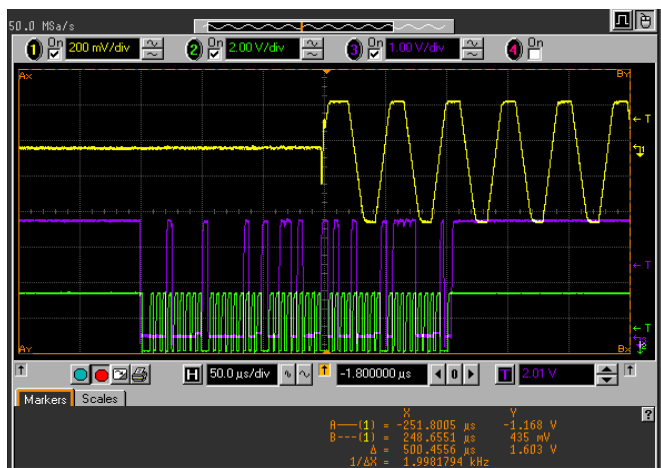

FIGURE 20. ISL9492 ENT BIT GOING HIGH TO TONE ENABLED ON THE OUTPUT DELAY

Typical Performance Curves (Continued)

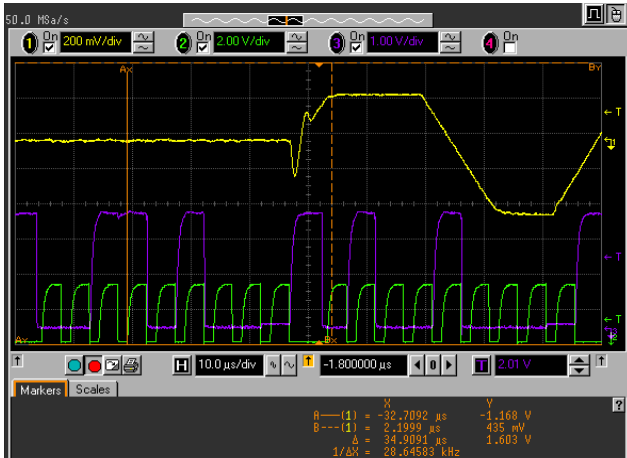

FIGURE 21. ENT BIT GOING HIGH TO TONE ENABLED ON THE OUTPUT DELAY IS $\sim 34\mu\text{s}$

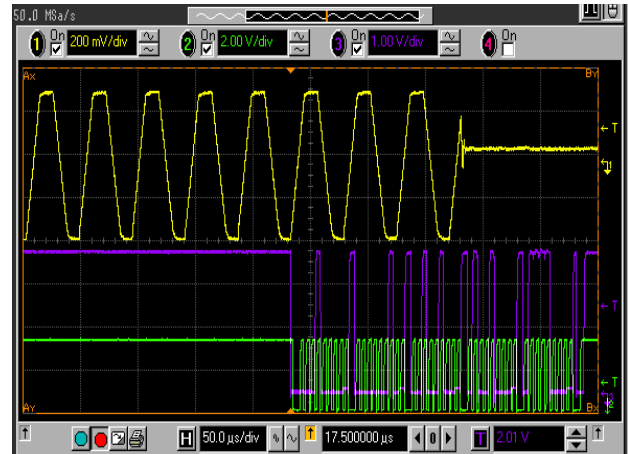

FIGURE 22. ISL9492 ENT BIT GOING LOW TO TONE DISABLED ON THE OUTPUT DELAY

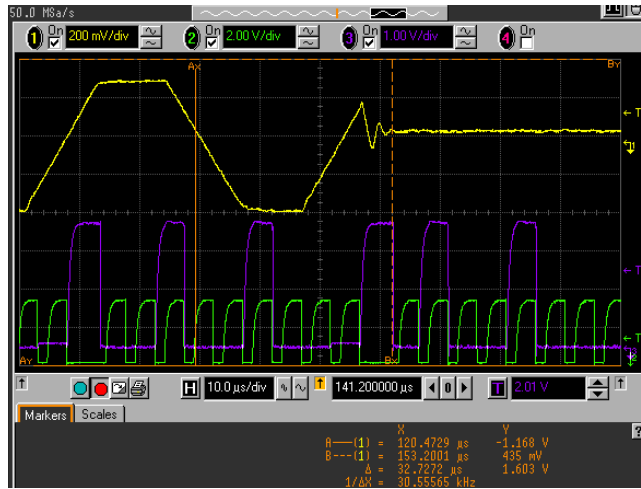

FIGURE 23. ENT BIT GOING LOW TO TONE DISABLED ON THE OUTPUT DELAY IS $\sim 32\mu\text{s}$

Derated Performance Curve

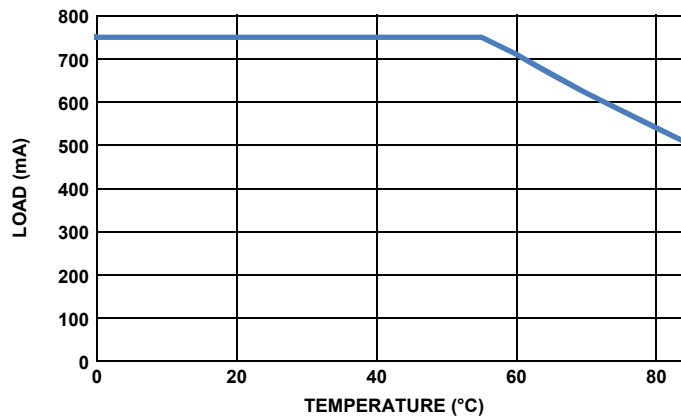

FIGURE 24. OUTPUT CURRENT DERATING

Functional Description

The ISL9492 single output voltage regulator is an ideal choice for advanced satellite set-top box and personal video recorder applications. The device utilizes built-in DC/DC step-up converters that generate a voltage for the linear regulator with minimal power dissipation. An undervoltage lockout circuit disables the device when V_{CC} drops below a fixed threshold.

DiSEqC Encoding

The tone signal can be generated in many different ways. External tone on the EXTM pin can be used when the ENT bit is low and the MSEL bit is high. The ISL9492 will inject an internal tone on V_{OUT} as long as:

- The EXTM pin is low, the ENT bit is high and the MSEL bit is low
- The ENT and MSEL bits are low and the EXTM pin is high

DiSEqC Decoder

If a tone signal is detected within the specified frequency range on TDIN thru a 10nF from V_{OUT} , the open drain pin TDOUT is asserted low. The detector threshold is 200mV (TTH bit = 0 and TXT pin is 0) in the Receive mode and 400mV (TTH = 1 or TXT = 1) in the Transmit mode.

ABYP

The ABYP pin provides 5V bias to the internal analog circuitry and the digital I²C block and is susceptible to noise pickup due to integrated high power boost MOSFET. In order to minimize any disturbance preventing the normal operation of the chip, it is recommended to add a ferrite bead (TDK part # MMZ1608S102A) in series with the decoupling capacitor.

Device Enable

The device can be enabled or disabled through the EN and DLIN bits. When both the EN and DLIN bits are LOW (default state), both the boost converter and the linear regulator are shut down, in which case, the boost output voltage will be $V_{in} - V_{diode}$ and the linear regulator will be at 0V. When both the EN and DLIN bits are HIGH, both power blocks are enabled. When the EN bit is high and the DLIN bit is low, the boost circuit is enabled and the linear regulator will be disabled.

DiSEqC External MOSFET

To transmit DiSEqC tone to the outside world, the external MOSFET Q1 in the "Typical Application Schematic" on page 5 has to be turned on by pulling the TXT pin or the TTH bit high. In order to receive tone from the LNB, the TXT pin or TTH bit should be pulled low.

Linear Regulator

In order to minimize the power dissipation, the output voltage of the boost converter is regulated to a voltage slightly higher than the desired LNB output voltage. The linear regulator has the capability to sink and source current from the LNB where this highly desirable feature allows full modulation capability into capacitive loads as high as 0.75 μ F.

Boost Regulator Inductor and Output Capacitor Selection

The ISL9492 boost regulator is internally compensated and relies on the inductor and output capacitor value for overall loop stability. It is recommended that the boost inductor be in the 8 μ H to 15 μ H range and the output capacitor in the 50 μ F to 200 μ F range with a worst case ESR of 40m Ω to 125m Ω . In case if the output capacitor is an Aluminum Electrolytic type, special attention should be paid to the increased ESR at low temperature due to freezing liquid electrolyte at around 0°C. The increased ESR can interfere with the overall stability by introducing a zero much sooner than anticipated at $1/2 \pi * R_{ESR} * C_{OUT}$. The following are some recommended part numbers which meet the above mentioned criteria:

- L = 10 μ H inductor - Sumida # CDR7D43MN-100
- C_{OUT} = 180 μ F capacitor - Panasonic # EKZE500ELL181MH20D

In case the output capacitor ESR is outside the recommended range, an additional external pole comprised of R_p and C_p needs to be inserted on VSWNS as shown in Figure 25 so that it cancels the ESR zero. Assuming $C_{OUT_ESR} = 230m\Omega$, $C_{OUT} = 100\mu F$ and $R_p = 100\Omega$, then C_p is calculated to be 0.22 μ F, as shown in Equation 1. The voltage rating on this capacitor should be in the 25V to 35V range since it is connected to the boost V_{OUT} rail.

$$C_p = \frac{ESR \times C_{out}}{100} \quad (EQ. 1)$$

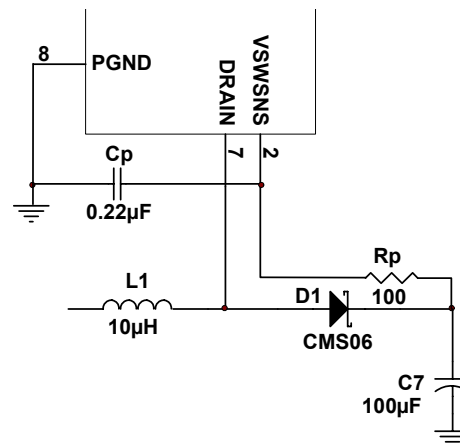

FIGURE 25. ADDITIONAL POLE ADDED BY R_p AND C_p TO COMPENSATE HIGH ESR ZERO

Output Timing

The output voltage rise and fall times can be set by an external capacitor on the TCAP pin. The output rise and fall times is given by Equation 2:

$$C = \frac{10T}{\Delta V} \quad (EQ. 2)$$

Where C is the TCAP value in nF, T is the required transition time in ms and ΔV is the differential transition voltage from low output voltage range to the high output range in Volts. Too large a value of TCAP prevents the output from rising to the nominal value, within the soft-start time when the error amplifier is released. Too small a value of the TCAP can cause high peak currents in the boost circuit. For example, a 10V/ms slew on a 80 μ F VSW

capacitor with an inductor of 15µH can cause a peak inductor current of approximately 1A.

Output Voltage Selection

The device offers a flexible means to select the output voltage. When VSPEN is LOW, the output voltage can be selected by the SVTOP pin. In this case, when the SVTOP pin is LOW, the output voltage is either 13V or 14V, depending on the VBOT bit. When the SVTOP pin is HIGH, the output voltage is either 18V or 20V depending on the VTOP bit. When VSPEN is HIGH, the SVTOP pin is ignored, and the output is selected by both the VTOP and the VBOT bits. See Table 1.

TABLE 1.

VSPEN	VTOP	VBOT	SVTOP	VOUT
0	X	0	0	13.5V
0	X	1	0	14.2V
0	0	X	1	18.5V
0	1	X	1	20V
1	0	0	X	13.5V
1	0	1	X	14.2V
1	1	0	X	18.5V
1	1	1	X	20V

Current Limiting

Both the boost converter and the linear regulator have independent current limit. In the boost converter, this is achieved through cycle-by-cycle internal current limit. In the linear regulator, current limit threshold is set by the ISELH and ISELL bits (see Table 9). At any time, when the linear regulator goes into current limit and the DCL bit is high, the OLF bit is set. OLF bit is not affected by current limit occurred through the boost converter. In this mode, the part will deliver the full specified current for 50ms. During this time, if the current limit condition disappears, the OLF bit will be cleared and the part restarts. If the part is still in current limit after this time period, the linear regulator and boost converter will automatically disable for 900ms to prevent the part from overheating. After this shutdown period, the ISL9492 will automatically re-enable itself and the above described sequence will repeat. This current limit method is also called "Dynamic current limit". The ISL9492 can also be configured so when a current limit is detected, the part rather than disabling the linear regulator after 50ms stays powered up and delivers the programmed load current in a constant current mode. This mode can be enabled by writing a "0" in the DCL bit. In this mode, the OLF bit is set high to indicate an overcurrent condition. This current limiting method is also called "Static Current Limit". This method can be used to enable any loads which are highly capacitive during start-up.

Thermal Protection and Fault Indicator

When the junction temperature reaches the critical temperature, the boost converter and the linear regulator are immediately disabled with the OTF bit set. Only when the junction temperature cools down to a lower temperature threshold specified will this bit will be cleared and the part be allowed to restart.

When any of the fault handling flags (OTF, CABF, OUVF, OLF, BCF) are set, the fault indicator pin \overline{FLT} will go LOW. This status output can serve as an interrupt signal to a microcontroller. The OUVF bit will be low indicating the output voltage is good and within 90% of final steady-state DC value, so during output voltage transitions, this bit will go high indicating output voltage is out of regulation followed by going low; see Figure 4. This bit can be used as an output for the system to know that the LNB output voltage is in regulation and it can start communicating with the LNB by transmitting the 22kHz tone. The system will be able to apply internal or external tone only after the OUVF bit is pulled low and during tone application, the bit will stay latched low. BCF bit is set when back bias is detected; OLF bit is set when an overcurrent is detected; CABF bit is set low when there is maximum of 50mA of load current; OTF bit is set when the die junction temperature reaches +150 °C; all these registers are activated after the LDO is enabled by the DLIN bit in SR4 register.

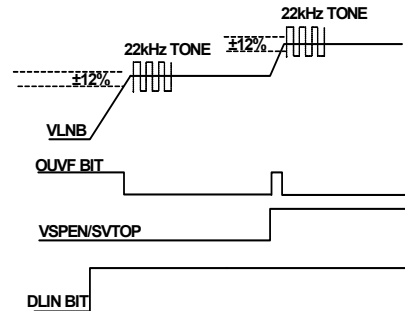

FIGURE 26. OUTPUT POWER SEQUENCE

I²C Bus Interface for ISL9492

(Refer to Philips I²C Specification, Rev. 2.1)

Data transmission from main microprocessor to the ISL9492 and vice versa takes place through the two-wire I²C bus interface, consisting of the two lines SDA and SCL. Both SDA and SCL are bidirectional lines, connected to a positive supply voltage via a pull-up resistor. (Pull-up resistors to positive supply voltage must be externally connected). When the bus is free, both lines are HIGH. The output stages of ISL9492 will have an open drain/open collector in order to perform the wired-AND function. Data on the I²C bus can be transferred up to 100kbps in the standard-mode or up to 400kbps in the fast-mode. The level of logic "0" and logic "1" is defined in the "Electrical Specifications" table on page 8. One clock pulse is generated for each data bit transferred.

Data Validity

The data on the SDA line must be stable during the HIGH period of the clock. The HIGH or LOW state of the data line can only change when the clock signal on the SCL line is LOW. Refer to Figure 27.

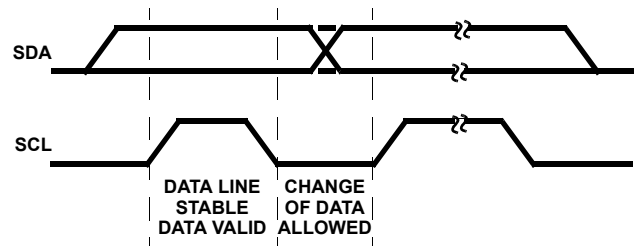

FIGURE 27. DATA VALIDITY

START and STOP Conditions

As shown in Figure 28, START condition is a HIGH to LOW transition of the SDA line while SCL is HIGH.

The STOP condition is a LOW to HIGH transition on the SDA line while SCL is HIGH. A STOP condition must be sent before each START condition.

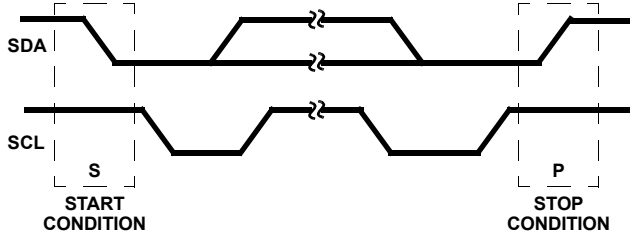

FIGURE 28. START AND STOP WAVEFORMS

Byte Format

Every byte put on the SDA line must be 8 bits long. The number of bytes that can be transmitted per transfer is unrestricted. Each byte has to be followed by an acknowledge bit. Data is transferred with the most significant bit first (MSB).

Acknowledge

The master (microprocessor) puts a resistive HIGH level on the SDA line during the acknowledge clock pulse (Figure 29). The peripheral that acknowledges has to pull-down (LOW) the SDA line during the acknowledge clock pulse, so that the SDA line is stable LOW during this clock pulse. (Note that set-up and hold times must also be taken into account.)

The peripheral which has been addressed has to generate an acknowledge after the reception of each byte, otherwise the SDA line remains at the HIGH level during the ninth clock pulse time. In this case, the master transmitter can generate the STOP information in order to abort the transfer. The ISL9492 will not generate the acknowledge if the POWER OK signal from the UVLO is LOW.

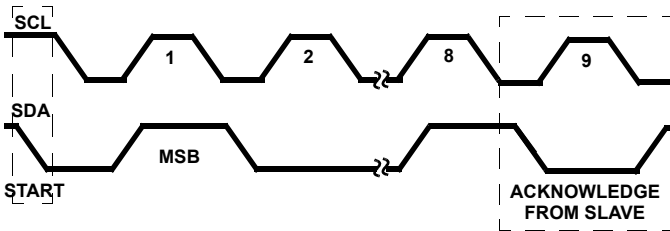

FIGURE 29. ACKNOWLEDGE ON THE I²C BUS

Transmission Without Acknowledge

Avoiding detection of the acknowledgement, the microprocessor can use a simpler transmission; it waits one clock without checking the slave acknowledging, and sends the new data.

This approach, however, is less protected from error and decreases the noise immunity.

ISL9492 Software Description

Interface Protocol

The interface protocol is comprised of the following, as shown in Table 2:

- A start condition (S)
- A chip address byte (MSB on left; the LSB bit determines read (1) or write (0) transmission) (the assigned I²C slave address for the ISL9492 is 0001 0XX)
- A sequence of data (1 byte + Acknowledge)
- A stop condition (P)

TABLE 2. INTERFACE PROTOCOL

S	0	0	0	1	0	A1	A0	R/W	ACK	Data (8 bits)	ACK	P
---	---	---	---	---	---	----	----	-----	-----	---------------	-----	---

System Register Format

- R, W = Read and Write bit
- R = Read-only bit

All bits reset to 0 at Power-On

TABLE 3. STATUS REGISTER (SR1)

R, W	R, W	R, W	R	R	R	R	R
SR1H	SR1M	SR1L	OTF	CABF	OUVF	OLF	BCF

TABLE 4. TONE REGISTER (SR2)

R, W	R, W	R, W	R, W	R, W	R, W	R, W	R, W
SR2H	SR2M	SR2L	ENT	MSEL	TTH	Res*	Res*

TABLE 5. COMMAND REGISTER (SR3)

R, W	R, W	R, W	R, W	R, W	R, W	R, W	R, W
SR3H	SR3M	SR3L	Res*	VSPEN	DCL	ISELH	ISELL

TABLE 6. CONTROL REGISTER (SR4)

R, W	R, W	R, W	R, W	R, W	R, W	R, W	R, W
SR4H	SR4M	SR4L	EN	DLIN	Res*	VTOP	VBOT

Transmitted Data (I²C Bus WRITE Mode)

When the R/W bit in the chip is set to 0, the main microprocessor can write on the system registers (SR2 thru SR4) of the ISL9492 via I²C bus. These will be written by the microprocessor as shown in Table 7. The spare bits of registers are reserved for further use.

ISL9492

TABLE 7. STATUS REGISTER SR1 CONFIGURATION

SR1H	SR1M	SR1L	OTF	CABF	OUVF	OLF	BCF	FUNCTION
0	0	0	X	X	X	X	X	SR1 selected
0	0	0	X	X	X	0	X	No current limit detected
0	0	0	X	X	X	1	X	Current limit detected in the linear regulator
0	0	0	X	X	X	X	0	No back-bias detected
0	0	0	X	X	X	X	1	Back-bias detected
0	0	0	X	X	0	X	X	V _{OUT} within specified range
0	0	0	X	X	1	X	X	V _{OUT} not within specified range
0	0	0	X	0	X	X	X	Cable connected
0	0	0	X	1	X	X	X	Cable open
0	0	0	0	X	X	X	X	Junction normal temperature
0	0	0	1	X	X	X	X	Junction over-temperature reached

TABLE 8. TONE REGISTER SR2 CONFIGURATION

SR2H	SR2M	SR2L	ENT	MSEL	TTH	Res*	Res*	FUNCTION
0	0	1	X	X	X	0	0	SR2 selected
0	0	1	0	0	X	0	0	Tone generated internally according to the state of the EXTMPin
0	0	1	0	1	X	0	0	Tone supplied by EXTMPin
0	0	1	1	0	X	0	0	Tone generated internally regardless of the EXTMPin
0	0	1	X	X	0	0	0	Decoder Rx threshold set
0	0	1	X	X	1	0	0	Decoder Tx threshold set

NOTE: X indicates "Read Only" and is a "Don't Care" for the Write mode. Res* is a reserved bit and should be "0"

TABLE 9. COMMAND REGISTER SR3 CONFIGURATION

SR3H	SR3M	SR3L	Res*	VSPEN	DCL	ISELH	ISELL	FUNCTION
0	1	0	0	X	X	X	X	SR3 selected
0	1	0	0	X	1	X	X	Dynamic current limit
0	1	0	0	X	0	X	X	Static Current limit
0	1	0	0	X	X	1	1	V _{OUT} current limit set to 400mA
0	1	0	0	X	X	1	0	V _{OUT} current limit set to 670mA
0	1	0	0	X	X	0	1	V _{OUT} current limit set to 790mA
0	1	0	0	X	X	0	0	V _{OUT} current limit set to 950mA
0	1	0	0	0	X	X	X	SVTOP pin enabled
0	1	0	0	1	X	X	X	SVTOP pin disabled

NOTE: X indicates "Read Only" and is a "Don't Care" for the Write mode. Res* is a reserved bit and should be "0"

TABLE 10. CONTROL REGISTER SR4 CONFIGURATION

SR4H	SR4M	SR4L	EN	DLIN	Res*	VTOP	VBOT	FUNCTION
0	1	1	X	X	0	X	X	SR4 selected
0	1	1	0	X	0	X	X	Device disabled
0	1	1	1	X	0	X	0	V _{OUT} = 13.4V if VSPEN = 0 and SVTOP = 0
0	1	1	1	X	0	X	1	V _{OUT} = 14.4V if VSPEN = 0 and SVTOP = 0
0	1	1	1	X	0	0	X	V _{OUT} = 18.7V if VSPEN = 0 and SVTOP = 1
0	1	1	1	X	0	1	X	V _{OUT} = 20V if VSPEN = 0 and SVTOP = 1
0	1	1	1	X	0	0	0	V _{OUT} = 13.4V if VSPEN = 1 and SVTOP = X
0	1	1	1	X	0	0	1	V _{OUT} = 14.4V if VSPEN = 1 and SVTOP = X
0	1	1	1	X	0	1	0	V _{OUT} = 18.7V if VSPEN = 1 and SVTOP = X
0	1	1	1	X	0	1	1	V _{OUT} = 20V if VSPEN = 1 and SVTOP = X
0	1	1	1	0	0	X	X	Internal linear regulator is turned-off but boost circuit is on
0	1	1	1	1	0	X	X	Internal linear regulator is turned-on and boost circuit is on

NOTE: X indicates "Read Only" and is a "Don't Care" for the Write mode. Res* is a reserved bit and should be "0"

Received Data (I²c bus READ MODE)

The ISL9492 can provide to the master a copy of the system register information via the I²C bus in read mode. The read mode is Master activated by sending the chip address with R/W bit set to 1. At the following Master generated clock bits, the ISL9492 issues a byte on the SDA data bus line (MSB transmitted first).

At the ninth clock bit the MCU master can:

- Acknowledge the reception, starting in this way the transmission of another byte from the ISL9492.
- Not acknowledge, stopping the read mode communication.

The read only bits of the register SR1 convey diagnostic information about the ISL9492, as indicated in Table 7.

Power-On I²C Interface Reset

The I²C interface built into the ISL9492 is automatically reset at power-on. The I²C interface block will receive a Power OK logic signal from the UVLO circuit. This signal will go HIGH when chip power is OK. As long as this signal is LOW, the interface will not respond to any I²C commands and the system register SR1 thru SR4 are all initialized to all zero, thus keeping the power blocks disabled. Once the V_{CC} rises above UVLO, the POWER OK signal to the I²C is asserted high, and the I²C interface becomes operative and the SR's can be configured by the main microprocessor. About 400mV of hysteresis is provided in the UVLO threshold to avoid false triggering of the Power-On reset circuit. (I²C comes up with EN = 0; EN goes HIGH at the same time as (or later than) all other I²C data for that PWM becomes valid).

ADD0 and ADD1 Pins

Connecting these pins to GND, the chip I²C interface address is 0001000, but, it is possible to choose between four different addresses by setting these pins to the logic levels indicated in Table 11.

TABLE 11. ADDRESS PIN CHARACTERISTICS

V _{ADDR}	ADD1	ADD0
V _{ADDR-1} "0001000"	0	0
V _{ADDR-2} "0001001"	0	1
V _{ADDR-3} "0001010"	1	0
V _{ADDR-4} "0001011"	1	1

Layout Guidelines

It is highly recommended to connect GND of C1, C6, C14, C2, C15, pins 8 and 9 in a tight formation on the top layer as shown in red circles in Figure 30 and needs to be returned back to the input power supply GND post, which is on the bottom left of the ISL9492QFNEVAL1 evaluation board. The ground side of the components in green circles along with the epad can be dropped

to the internal ground plane which connects to the top ground plane with 8-10 vias near C1 to form a star ground connection. Refer to [AN1629](#) "ISL9492 Quick Start Guide"

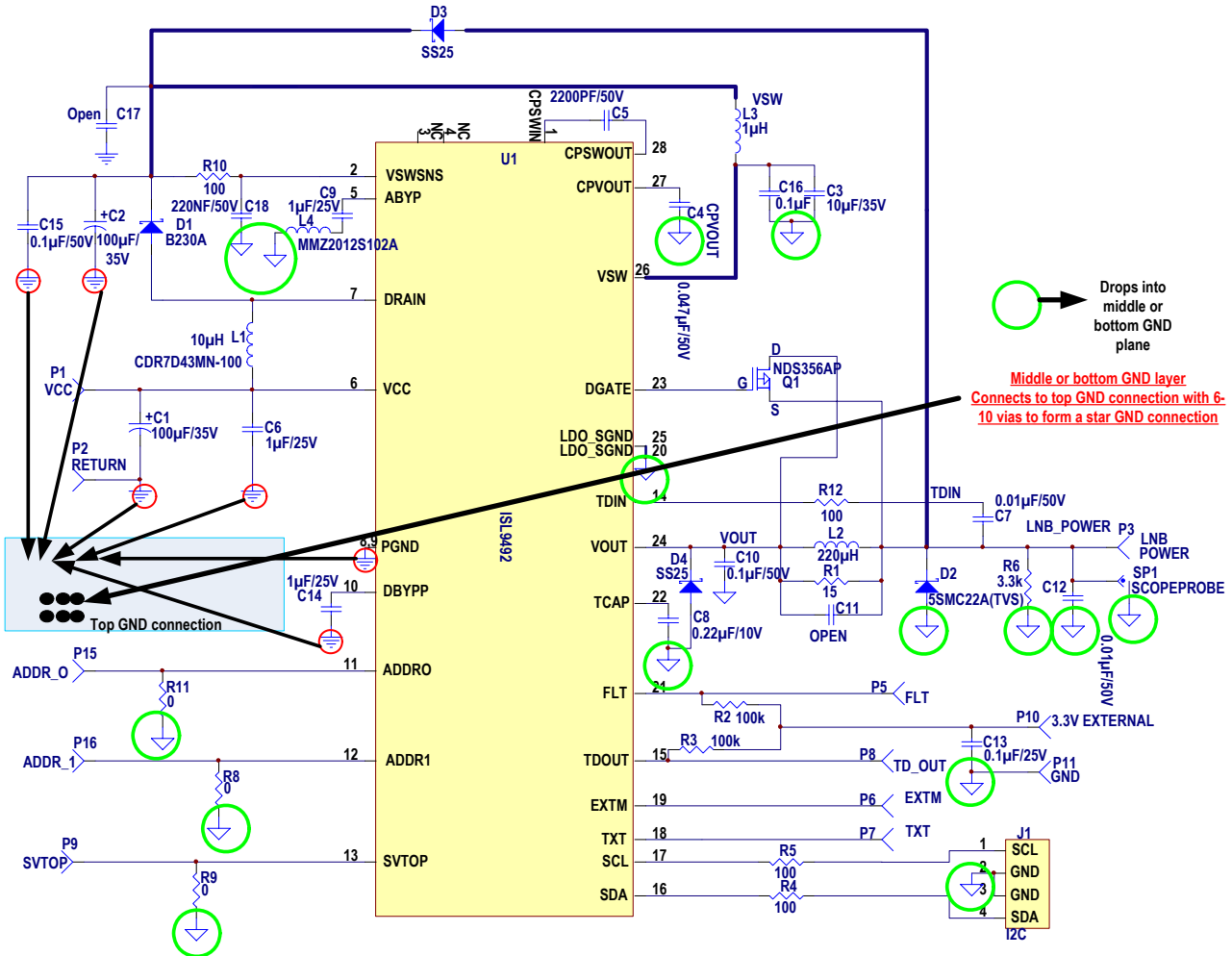

FIGURE 30. ISL9492 STAR GROUND CONNECTION ILLUSTRATION

Revision History

The revision history provided is for informational purposes only and is believed to be accurate, but not warranted. Please go to web to make sure you have the latest Rev.

DATE	REVISION	CHANGE
3/4/11	FN6547.1	Changed in Typical Application Schematic on page 1 and page 5 bottom D3 which was duplicated to D4.
3/2/11		Added Layout Guidelines on page 19.
1/28/11	FN6547.0	Initial Release

Products

Intersil Corporation is a leader in the design and manufacture of high-performance analog semiconductors. The Company's products address some of the industry's fastest growing markets, such as, flat panel displays, cell phones, handheld products, and notebooks. Intersil's product families address power management and analog signal processing functions. Go to www.intersil.com/products for a complete list of Intersil product families.

*For a complete listing of Applications, Related Documentation and Related Parts, please see the respective device information page on intersil.com: [ISL9492](http://www.intersil.com/ISL9492)

To report errors or suggestions for this datasheet, please go to www.intersil.com/askourstaff

FITs are available from our website at <http://rel.intersil.com/reports/search.php>

For additional products, see www.intersil.com/product_tree

Intersil products are manufactured, assembled and tested utilizing ISO9000 quality systems as noted in the quality certifications found at www.intersil.com/design/quality

Intersil products are sold by description only. Intersil Corporation reserves the right to make changes in circuit design, software and/or specifications at any time without notice. Accordingly, the reader is cautioned to verify that data sheets are current before placing orders. Information furnished by Intersil is believed to be accurate and reliable. However, no responsibility is assumed by Intersil or its subsidiaries for its use; nor for any infringements of patents or other rights of third parties which may result from its use. No license is granted by implication or otherwise under any patent or patent rights of Intersil or its subsidiaries.

For information regarding Intersil Corporation and its products, see www.intersil.com

Package Outline Drawing

L28.4x4A

28 LEAD THIN QUAD FLAT NO-LEAD PLASTIC PACKAGE

Rev 1, 12/08

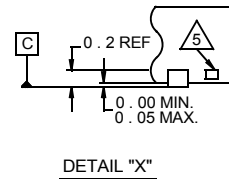
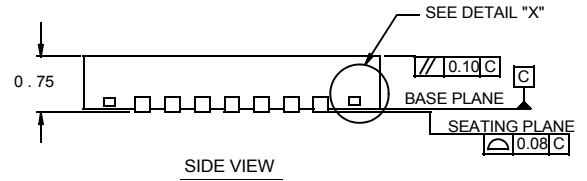
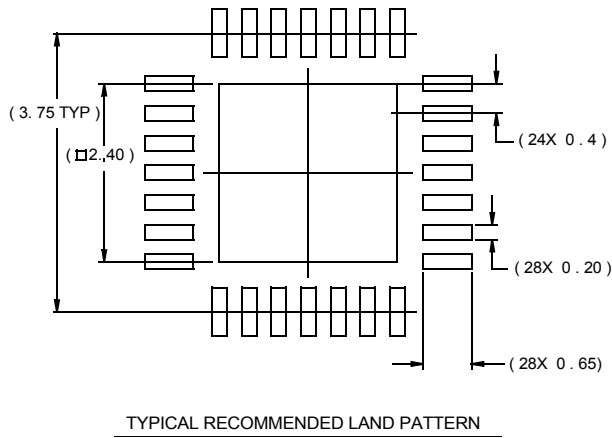
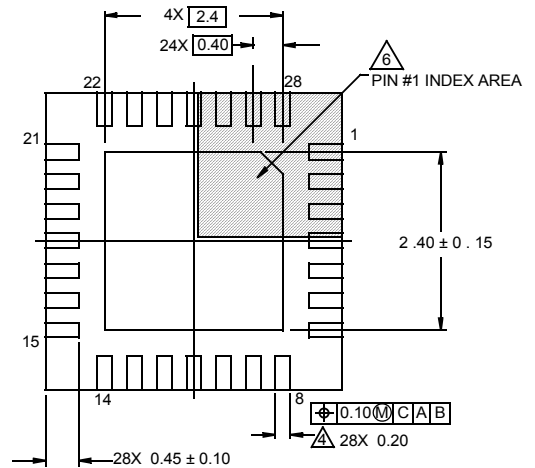
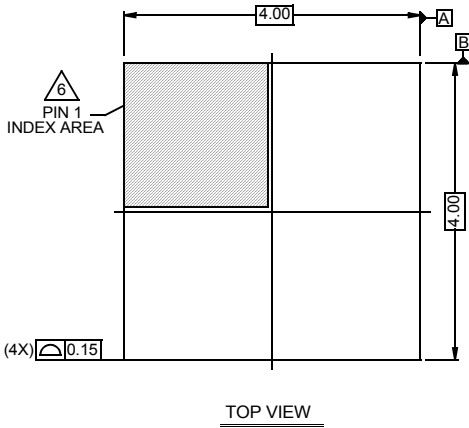

NOTES:

1. Dimensions are in millimeters.
Dimensions in () for Reference Only.
2. Dimensioning and tolerancing conform to AMSE Y14.5m-1994.
3. Unless otherwise specified, tolerance : Decimal ± 0.05
4. Dimension b applies to the metallized terminal and is measured between 0.15mm and 0.30mm from the terminal tip.
5. Tiebar shown (if present) is a non-functional feature.
6. The configuration of the pin #1 identifier is optional, but must be located within the zone indicated. The pin #1 identifier may be either a mold or mark feature.